

## PARALLEL SURFACE

### D93023

PROJECT	
TYPE	
NOTES	
QUANTITY	
DATE	

#### GENERAL

Series: Paral.Lel
Brand: Milan
Division: Design
Mounting Type: Surface
Mounting Location: Wall
Subcategory: Wall Effect

#### PHYSICAL

Shape: Rectangle
Length (mm): 224
Length (in): 8 <sup>13</sup> / <sub>16</sub>
Height (mm): 69
Height (in): 2 <sup>11</sup> / <sub>16</sub>
Extension (mm): 89
Extension (in): 3 <sup>1</sup> / <sub>2</sub>
Weight (kg): 1.23
Weight (lbs): 2.7
Fixture Material: Metal

#### ELECTRICAL

Number of Lamps: 2
Lamp Type: LED Retrofit
Lamp Shape: T4
Bulb Included: Bulb Not Included
Total Output Wattage (W): 6
Max. Wattage Per Lamp (W): 3
Lamp Base: G9
Input Voltage (V): 120

#### LED

#### OPTICAL

#### RATINGS AND CERTIFICATIONS

Certified By: CSA Certified to UL and CSA Standards
IP rating: IP20

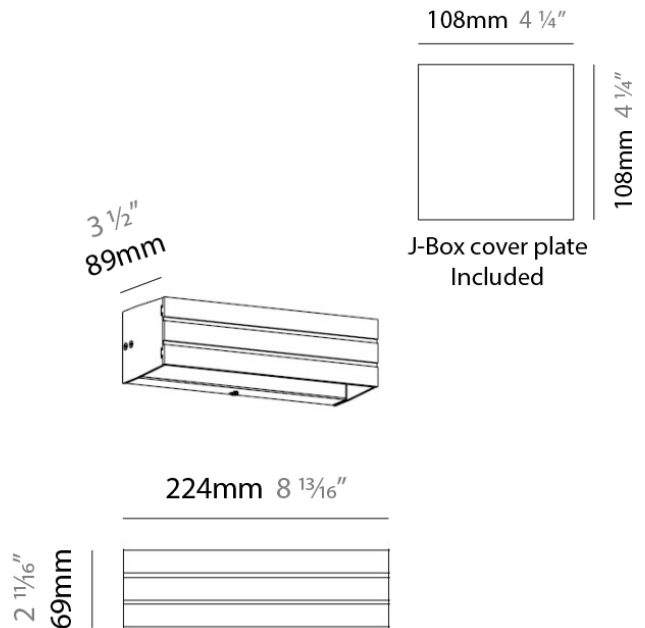

## PARALLEL SURFACE

### D93024

PROJECT	
TYPE	
NOTES	
QUANTITY	
DATE	

#### GENERAL

Series: Paral.Lel  
 Brand: Milan  
 Division: Design  
 Mounting Type: Surface  
 Mounting Location: Wall  
 Subcategory: Wall Effect

#### PHYSICAL

Shape: Rectangle  
 Length (mm): 335  
 Length (in): 13 3/16  
 Height (mm): 69  
 Height (in): 2 11/16  
 Extension (mm): 89  
 Extension (in): 3 1/2  
 Weight (kg): 1.63  
 Weight (lbs): 3.6  
 Fixture Material: Metal

#### ELECTRICAL

Number of Lamps: 3  
 Lamp Type: LED Retrofit  
 Lamp Shape: T4  
 Bulb Included: Bulb Not Included  
 Total Output Wattage (W): 6  
 Max. Wattage Per Lamp (W): 3  
 Lamp Base: G9  
 Input Voltage (V): 120

#### LED

#### OPTICAL

#### RATINGS AND CERTIFICATIONS

Certified By: CSA Certified to UL and CSA Standards  
 IP rating: IP20

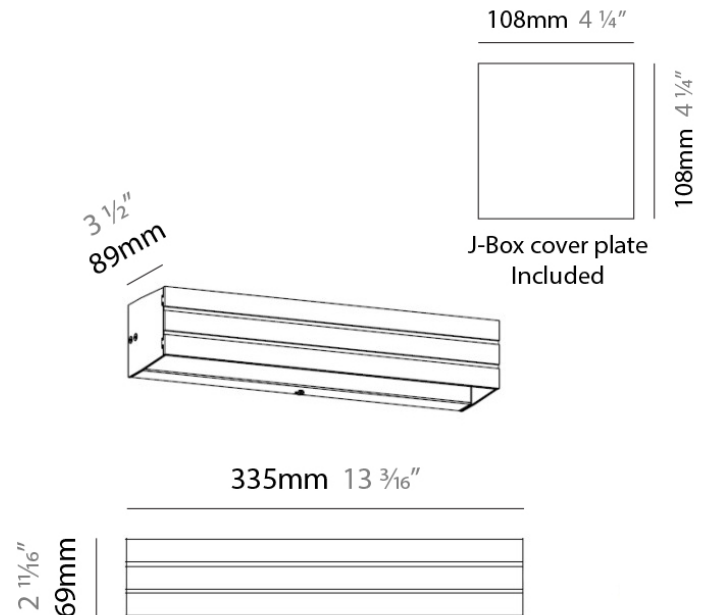
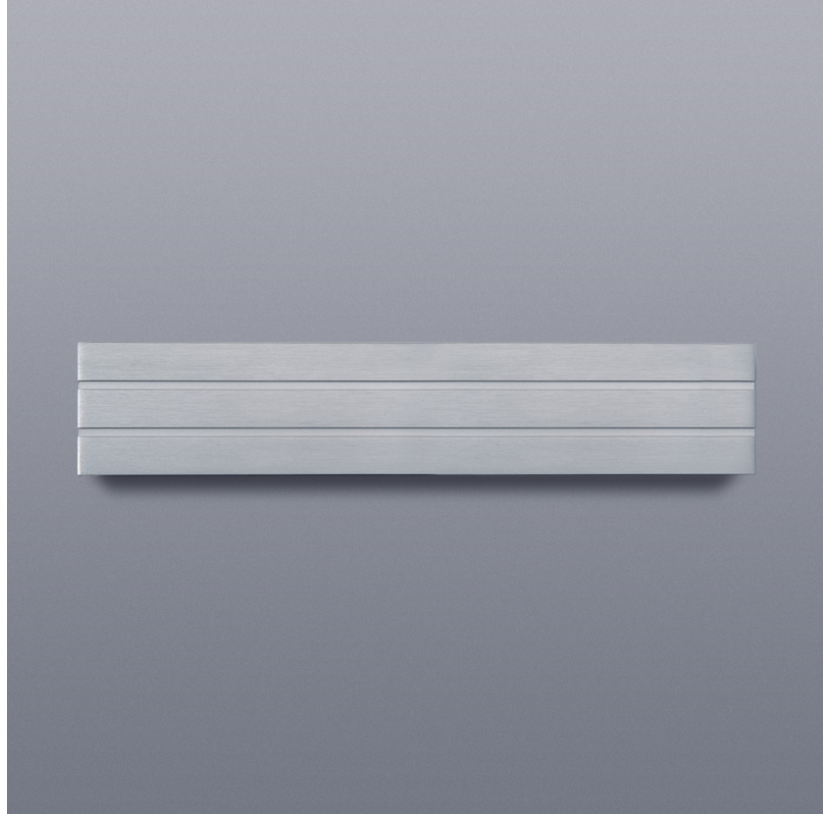

## PARALLEL SURFACE

### D93025

PROJECT	
TYPE	
NOTES	
QUANTITY	
DATE	

#### GENERAL

Series: Paral.Lel  
 Brand: Milan  
 Division: Design  
 Mounting Type: Surface  
 Mounting Location: Wall  
 Subcategory: Wall Effect

#### PHYSICAL

Shape: Rectangle  
 Length (mm): 115  
 Length (in): 4 1/2  
 Height (mm): 100  
 Height (in): 3 15/16  
 Extension (mm): 89  
 Extension (in): 3 1/2  
 Weight (kg): 1.23  
 Weight (lbs): 2.7  
 Fixture Material: Metal

#### ELECTRICAL

Number of Lamps: 1  
 Lamp Type: LED Retrofit  
 Lamp Shape: T4  
 Bulb Included: Bulb Not Included  
 Total Output Wattage (W): 9  
 Max. Wattage Per Lamp (W): 3  
 Lamp Base: G9  
 Input Voltage (V): 120

#### LED

#### OPTICAL

#### RATINGS AND CERTIFICATIONS

Certified By: CSA Certified to UL and CSA Standards  
 IP rating: IP20

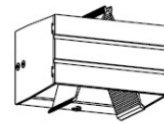

108mm 4 1/4"



108mm 4 1/4"

J-Box cover plate  
Included

89mm 3 1/2"

115mm 4 1/2"

100mm 3 15/16"

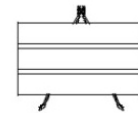
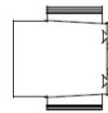

## PARALLEL SURFACE

### D93026

PROJECT	
TYPE	
NOTES	
QUANTITY	
DATE	

#### GENERAL

Series: Paral.Lel  
 Brand: Milan  
 Division: Design  
 Mounting Type: Surface  
 Mounting Location: Wall  
 Subcategory: Wall Effect

#### PHYSICAL

Shape: Rectangle  
 Length (mm): 224  
 Length (in): 8 <sup>13</sup>/<sub>16</sub>  
 Height (mm): 100  
 Height (in): 3 <sup>15</sup>/<sub>16</sub>  
 Extension (mm): 89  
 Extension (in): 3 <sup>1</sup>/<sub>2</sub>  
 Weight (kg): 1.23  
 Weight (lbs): 2.7  
 Fixture Material: Metal

#### ELECTRICAL

Number of Lamps: 2  
 Lamp Type: LED Retrofit  
 Lamp Shape: T4  
 Bulb Included: Bulb Not Included  
 Total Output Wattage (W): 3  
 Max. Wattage Per Lamp (W): 3  
 Lamp Base: G9  
 Input Voltage (V): 120

#### LED







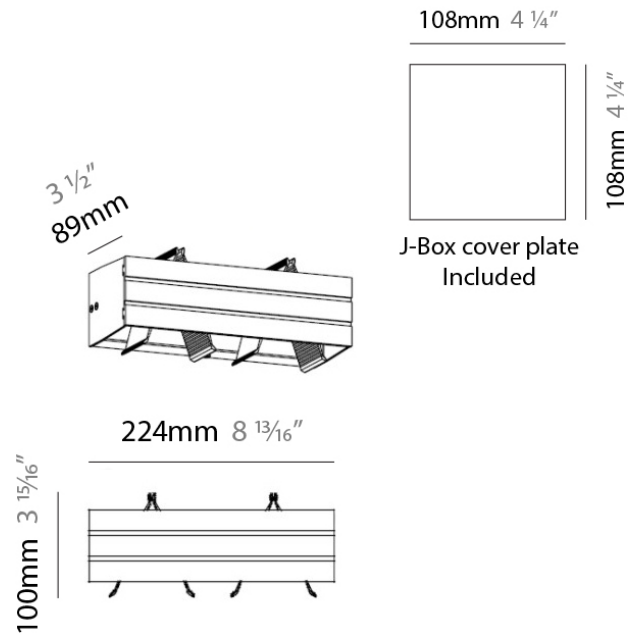





























































#### OPTICAL

#### RATINGS AND CERTIFICATIONS

Certified By: CSA Certified to UL and CSA Standards  
 IP rating: IP20



## LEGEND

	floor-mounted		pivotable		special LED (upon request) RGB, RGBW, tunable, gold+, meat+, art+, fashion+
	wall and ceiling: recessed and surface mounted		rotating		warm dim / natural dimming LED
	ceiling-mounted and wall-mounted		illuminate tilted		rechargeable battery powered
	wall-mounted		color of suspension cable		fixture with natural vivid LED (upon request)
	omni-directional light distribution		length of suspension cable		color rendering index
	direct light distribution		reflector degree selection		color temperature
	direct/indirect light distribution		super spot		lumen (luminous flux)
	indirect light distribution		lens		efficacy (lumens per watt)
	asymmetric light distribution		lens pack		Unified Glare Rating (UGR) range from 5-40
	aura light distribution		shine ring		marine grade (AISI 316 stainless steel)
	round wall or ceiling cut-out		integrated shine ring with diffuser		walk on
	square wall or ceiling cut-out		free individual colors 01-29		drive on
	the supplied jig specifies the cutout dimensions		individual colors: 00 (free of charge), 01-25 (extra charge)		Dark Sky Compliance
	minimum distance (meters) lamp - object		luminaire part to be colored (F1)		Americans with Disabilities Act (less than 4" off the wall located between 27"-84" from floor)
	recessed depth		luminaire part to be colored (F2)		lamp protected against explosion
	ceiling thickness in mm		luminaire part to be colored (F3)		blown glass using traditional methods by master glass blower
	ceiling thickness selection		luminaire part to be colored (F4)		acoustic material
	dimnable DP (phase), DV (0-10V), DD (dali), DS (step-dim)		luminaire part to be colored (F5)		protection class I, protection insulation
	included or excluded LED driver/transformer/control gear		color of 3-circuit adaptor		protection class II, protection insulation
	separately switchable		indirect diffuser		ETL Certified to UL and CSA Standards
	sensor		direct diffuser		UL Certified to UL and CSA Standards
	remote control		ball-proof (upon request)		CSA Certified to UL and CSA Standards
	available upon request		accessory		Certified for North American Standards

## IP RATING

	protected against ingress of solid bodies greater than 12.5mm (finger)
	protected against ingress of solid bodies greater than 2.5mm protected against sprays of water up to 60 degrees from the vertical (rain)
	protected against ingress of solid bodies greater than 1mm (wire) no protection against the ingress of moisture
	protected against ingress of solid bodies greater than 1mm (wire) protected against sprays of water up to 60 degrees from the vertical (rain)
	protected against ingress of solid bodies greater than 1mm (wire) protected against water splashed from all directions
	protected against limited ingress of dust (wet rooms/covered outdoor areas) protected against water splashed from all directions
	protected against ingress of dust protected against jets of water
	protected against ingress of dust protected against powerful jets of water or heavy seas
	protected against ingress of dust protected against immersion of water between 15cm - 1m for 30 minutes
	protected against ingress of dust protected against immersion of water under pressure for long periods

## IK RATING

	protected against 0.14 joules impact (equivalent to 0.25kg mass dropped from 56mm above the surface)
	protected against 0.2 joules impact (equivalent to 0.25kg mass dropped from 80mm above the surface)
	protected against 0.35 joules impact (equivalent to 0.25kg mass dropped from 140mm above the surface)
	protected against 0.5 joules impact (equivalent to 0.25kg mass dropped from 200mm above the surface)
	protected against 0.7 joules impact (equivalent to 0.25kg mass dropped from 280mm above the surface)
	protected against 1 joules impact (equivalent to 0.25kg mass dropped from 400mm above the surface)
	protected against 2 joules impact (equivalent to 0.5kg mass dropped from 400mm above the surface)
	protected against 5 joules impact (equivalent to 1.7kg mass dropped from 300mm above the surface)
	protected against 10 joules impact (equivalent to 5.0kg mass dropped from 200mm above the surface)
	protected against 20 joules impact (equivalent to 5.0kg mass dropped from 400mm above the surface)